



k2

Soundcraft



Soundcraft

Experience Counts



Sometimes there's just no substitute for experience. Live sound puts special demands on both equipment and personnel, because there's no second take, and because anything less than total reliability can mean disaster. Then there's the physical punishment of touring, the need to work in a wide variety of environments. After 23 years of designing and building mixers for professional live sound, Soundcraft has earned a reputation that's second to none, because we listen to

engineers at the cutting edge, and take notice.

The K2 is our most cost-effective fully-featured 8-bus live console ever, taking advantage of Soundcraft's

long experience in live sound to deliver, in a straightforward package, all the facilities you need for a first-rate production.

The K2 includes many features that you'd expect only on a much bigger console – like an advanced solo system, true left-centre-right busing, a built-in matrix, and full 4-band EQ – equipping it for a range of applications from touring with bands, to fixed installations in theatres, clubs, or places of worship. The desk is available in a choice of four frame sizes from 24 to 48 mono input channels, with an additional eight stereo input channels. Its specially designed steel monocoque frame provides excellent physical protection for all audio circuitry, based around discrete vertical PCBs.

Sound quality is assured through the use





of circuits based on classic Soundcraft designs such as the award-winning Europa and Vienna. The advanced pre-amp delivers superb low-noise performance no matter what you throw at it. The sweepable high-pass filter offers more control over low frequency problem signals than any other comparable design. The 4-band EQ offers the precision required to correct problems in the mix, and the gentle tonal control required in sweetening. A built-in VU meterbridge provides clear metering of output levels in all lighting conditions, and there are pre-fade input meters next to each fader. The channel muting provides the flexibility of both mute groups and snapshot automation, as



well as MIDI-controlled muting. Despite all this, however, the K2 is thoroughly straightforward in use. We know all too well that, even in low light, it must be immediately clear how to adjust channel EQ or FX send levels, or solo a particular channel. The channel layout, the colour and size of rotary pots, and the facia graphics have all been designed with this in mind. So, whether you're familiar with Soundcraft desks or not, the clear layout and attention to ergonomic detail ensures that you'll be confident and fully in control. When you choose an 8-bus live console, choose one that's been designed by someone who knows what they're doing.



Take control of your mix

The K2 offers facilities and quality demanded by top engineers and productions, yet makes it as simple as possible to use. Functionality, simplicity and quality are to be found throughout the K2.

SOUND QUALITY

As soon as you plug your first input into the K2, you know you're dealing with something special. All mono inputs have the same high-quality input stage as the Soundcraft Vienna and Europa, an advanced low noise circuit that can handle mic or line level signals without using a signal-degrading 'pad'. The Range switch removes a gain stage when dealing with line level signals. This

reduces noise by keeping the signal path as direct as possible whilst

setting the appropriate input sensitivity. An 8-segment LED meter next to the fader provides simple input level monitoring so that gain can be correctly set. Inputs are via high-quality XLRs and jacks, mounted securely on the steel monocoque for reliability.

SOUND CONTROL

Soundcraft has always been well known for quality filter and EQ facilities, and the K2 breaks new ground by including a swept 20-400Hz high-pass filter, previously only found on top-end live consoles. Perhaps one of the most underrated facilities on a live mixer, a good HPF allows problem low frequency signals to be easily removed without using up a valuable EQ band. The main EQ section features a development of Soundcraft's classic 4-band EQ, with two swept mids and shelving high and low bands. Thanks to switchable Q on the mid bands, plus carefully chosen frequency ranges and filter shapes, this provides the perfect balance of corrective ability and creative control – whether you're mixing rock'n'roll, or speech and effects in a theatre.

On both stereo input channels and stereo FX returns, you can vary the stereo width from mono through standard stereo to phase-enhanced 'super wide' stereo, opening up more creative possibilities in mixing.

EASE OF USE

The K2's advanced solo system means you can troubleshoot a mix quickly and





pre/post fade in pairs. Even the channel faders have been designed to enhance ease of use: with increased resolution around unity gain, your fader adjustments produce precise and predictable results.

FLEXIBLE SIGNAL ROUTING

The K2's input modules and master section are based around a console architecture designed for maximum flexibility. In addition to the mono channels, all K2 consoles come with four stereo input channels, for stereo line level sources, or extra effects returns. A mono Centre output is provided alongside the main left and right output, allowing for centre cluster or sub-bass system feeds. There are insert

points on channels, groups and the output buses, for dynamics or EQ processors.

To make the four stereo effects returns as versatile as possible, each features 2-band

EQ and two aux sends. The desk is compact and clearly laid-out, yet a full 11 x 4 matrix section is located above groups 5-8, making it easy to set up additional feeds for auxiliary speaker

systems, monitor mixes, or broadcast or recording feeds.

Even without the matrix, however, the eight sub-groups and eight aux sends can accommodate a wide variety of foldback, effects send/return, and speaker feeds. You can even swap signals between aux send pots and sub-group faders, for easier control of foldback mixes.

The powerful mute system covers all channels, returns, sub-groups and matrix outputs, combining the flexibility of mute groups with snapshots of the console's mute status. It also talks MIDI – each snapshot memory can be recalled by and can generate MIDI program change messages. Again, ease of use is a priority, with Active and Preview buttons that allow you to preview a snapshot at a glance before recalling it.



cleanly, with a minimum of button-pushing. In Autocancel mode, hitting any solo button cancels any existing solos and gives immediate pre-fade listen for that channel only. Solo-in-place is also available, enabling any input to be heard in its correct pan position, with effects. Best of all, "the all important solo button" is located where it can easily be found in an emergency, at the bottom of the channel strip, with no other controls to catch a wayward finger. The eight aux sends each have individual level pots – there are no shared controls to cause confusion – and are switched



Channels

Mono Input Channel

The K2's input stage, using the same circuit as the Europa and Vienna, has been designed to handle a wide range of signals with minimal noise. The electronically balanced XLR input can accept mic or line level signals, with the sensitivity controlled by the Range switch (-2dBu to -70dBu, +10dBu to -20dBu). The circuit is entirely active, with no performance-degrading pad. A high impedance electronically balanced jack input socket will accept line level signals. Phase reverse and phantom power switching are provided on every channel.

The swept high pass filter is a second order (12dB/octave) type, offering effective low-frequency attenuation across its range of 20-400Hz. This allows signals to be cleaned up without using a valuable EQ band. The channel insert is by default immediately after the filter and before the EQ, but can be re-configured by internal jumpers to appear post-EQ.

The 4-band EQ is based on Soundcraft's classic live EQ, with shelving high and low bands and two swept mids. The high and low bands offer ± 15 dB of cut/boost at 12kHz and 60Hz respectively. The low mid section offers ± 15 dB of cut/boost at 60Hz to 1kHz, with Q switchable between 1.3 and 2.7. The high mid section offers ± 15 dB of cut/boost at 400Hz to 10kHz, with Q switchable between 1.3 and 2.7. An EQ in/out switch is provided.

Individual send controls are provided for all eight auxes, which are switched pre/post-fade in pairs. Internal jumpers set the aux source relative to mute, EQ and insert.

The channel direct output, on a jack socket, is fed either directly from the channel fader or from the aux 8 pot via the DIR button.

Routing buttons address eight sub-groups in pairs, and the main stereo bus, via a pan control, and a centre (mono) bus independent of pan. The high-quality 100mm channel fader offers 10dB of gain when fully raised, with an expanded scale around the critical 0dB mark for precise level control.

The channel mute, switched by the channel Mute switch or the MIDI mute system, mutes all feeds from the input channel. The Preview LED allows editing and checking of mute groups and snapshots without affecting the audio passing through the channel. The electronically-latching Solo button switches the pre-fader post-EQ signal to the monitor/phones output. If Solo-In-Place mode is selected in the master section then all other input channels are muted when solo is selected, allowing the channel to be auditioned with effects and routing in place.

An 8-segment LED peak-reading bargraph meters the signal at the input amplifier. The Peak LED monitors the input amplifier, EQ output and post-fader output signals, providing 6dB warning before clipping.

Mono input options:

Transformer balanced XLR input.



Stereo Input Channel

Four of these full-length stereo input channels are fitted to all frame sizes, in addition to the full complement of mono inputs.

Left and right line inputs are on electronically balanced jacks. The left input can be used as a mono input to the channel, feeding both sides equally. The phase of the left channel only can be inverted with the Phase switch.

The Sens knob adjusts input sensitivity from +10 to -20dBu.

The Width control alters the stereo image from mono, through normal stereo, to phase-enhanced 'super stereo'.

The 3-band EQ offers shelving high and low frequency bands, with ± 15 dB at 12kHz and 60Hz, and a swept mid band with ± 15 dB variable from 300Hz to 3kHz, and a Q of 1. An EQ in/out switch is provided.

A stereo insert provides an unbalanced pre-EQ pre-fader send/return via two jack sockets.

The eight aux sends are switched pre/post-fade in pairs. Internal jumpers set whether they are pre or post-EQ, and whether they are stereo sends (left feeds odd sends, right feeds even) or a mono sum.

A 100mm fader sets the channel output level.

The post-fade post-balance signal is fed to the main stereo bus, or to the eight subgroups in pairs - left feeds odd channels, right feeds even. The mono bus uses a post-fade mono sum. The channel mute, switched by the channel Mute switch or the desk mute system, mutes all feeds from the input channel. The Preview LED allows editing and checking of mute groups and snapshots without affecting the audio passing through the channel.

The electronically-latching solo button switches a mono sum of the pre-fader post-EQ signals to the monitor/phones output. If Solo-In-Place mode is selected in the master section then all other input channels are muted when solo is selected, allowing the channel to be auditioned with effects and routing in place.

The Mute Safe switch protects the channel from muting if another channel is soloed, or from the MIDI muting system.

Options:

Transformer balanced/multi-pin connection.



Group/FX Return Section

Group modules 1-4 each include a full stereo return section, with 2-band shelving EQ (60Hz and 12kHz, ± 15 dB), and the same type of Width control as the stereo input channels. Two aux send pots access either auxes 1 & 2 or auxes 3 & 4, selected by a push-button. The stereo signal is sent to the main stereo bus, or the eight sub-groups in pairs, via a balanced control and 60mm fader. An internal jumper selects either pre or post-fade source for the auxes (default is post).

The FX return solo button offers mono PFL, or stereo solo-in-place. The recessed mute safe switch protects the input from being muted during solo-in-place operations on other inputs. The FX return can be muted directly from the input, or via the MIDI muting system.

Each sub-group module includes one of the eight aux master sends, feeding an electronically balanced output on the rear panel. AFL solo is provided. The Swap button redirects the module's sub-group and aux bus signals, such that the aux signal now flows through the long throw fader, its meter and its insert point (see below), and the sub-group signal flows via the rotary fader. This allows, for example, an aux send to be used as a monitor feed, with fader control and graphic EQ insert.

The sub-group master output is via a 100mm fader and pan pot, feeding the master stereo bus and/or the mono centre bus. A rear panel insert point is provided.

The integral meter overbridge contains 11 backlit VU meters for the eight subgroup outputs, and the main left, right and centre outputs. A switch at the top of the sub-group module allows any of the FX returns to be metered instead.



Matrix/Sub-group Section

Sub-groups 5-8 each include a full matrix mixing capability, allowing a mono feed to be derived from a mix of the eight subgroups, and the left, right, and mono output signals. Each Matrix output has AFL solo and muting facilities. The four outputs appear on electronically balanced XLRs on the rear panel. A switch at the top of the sub-group module allows any of the matrix outputs to be metered instead of the sub-group.



Master Section

The oscillator generates a sine wave signal or pink noise, routed to all buses and via a balanced jack output. Sine wave frequency is variable from 63Hz to 10kHz, and level is variable via a rotary fader. A dynamic talkback mic can be plugged into the front panel XLR. Talkback signal is routed via a rotary pot and the appropriate button to auxes 1-4, auxes 5-8, the eight groups, or an external line level XLR output. This includes a DC switching signal for use as an intercom with other Soundcraft consoles. The 2-track return section routes either of two rear panel stereo inputs to the main mix bus, via a rotary level control. A recessed switch selects -10dBV or +4dBu for the balanced rear panel jacks. The global solo controls affect how the solo system operates. The SIP Enable button selects stereo solo-in-place for all inputs rather than mono PFL or AFL. Enabling Autocancel ensures that whenever a solo button is pressed, all other desk solos are cancelled. Otherwise, several solos can be selected at once. The Solo Clear button removes all solos instantly. The Solo/AFL trim control gives ± 10 dB of adjustment on the solo signal in the monitor/phones output. The stereo monitor output and headphones output are fed via the rotary level control with a signal derived from the master stereo bus unless any signal is soloed, in which case this replaces the master stereo signal. Two 100mm faders control the left, right, and centre output levels, in one of two ways. Either the faders control left and right levels respectively, with the centre bus fixed at unity gain, or the left-hand fader controls the left/right stereo level signal, and the right-hand fader the mono level. A recessed switch determines the fader mode. Insert points are provided for left, right and centre buses.



Mute Control Section

The Mute section allows the creation of eight mute groups and up to 128 mute snapshots, and also the generation and reception of MIDI program change messages. The Dump In and Out buttons allow the memory contents to be transferred and stored via MIDI System Exclusive data. The Active and Preview buttons select their respective mute modes. In Active mode, recalling any mute snapshot will immediately override all existing desk mutes. In Preview mode, no settings are changed when a snapshot is recalled, and the snapshot's mute status is indicated by flashing the Preview LEDs on all appropriate Mute buttons. Snapshots can also be edited and re-stored in this mode. Mute groups can also be checked in this way, again without disturbing the audio. The 3-digit 7-segment LED display allows selection and display of snapshot number and, together with the Up/Yes & Down/No buttons, and MIDI channel and Program Change buttons, the adjustment of these other parameters. Store and Recall are used to create and recall mute snapshots. Illuminated buttons are provided for activating each mute group. A mute group is created by selecting the channels required by pressing their mute buttons; this can be done in Preview mode, if it is necessary to avoid muting the audio in the channels. The Store button is then held down whilst selecting the desired mute master button, to save the group. Once programmed, mute groups can be selected in any combination – overlapping groups is possible. The MIDI control capability gives a number of benefits: program changes sent from the K2 allow an external FX rack to select the relevant patches for a particular scene, or conversely the K2's mute snapshots can be automatically recalled by another piece of equipment such as a lighting desk. Each mute switch on the K2 generates MIDI Note On messages when unmuted. This provides an ideal way of triggering sound effects from a MIDI sampler, allowing the sample to be triggered when the appropriate input channel is unmuted.



Block Diagram

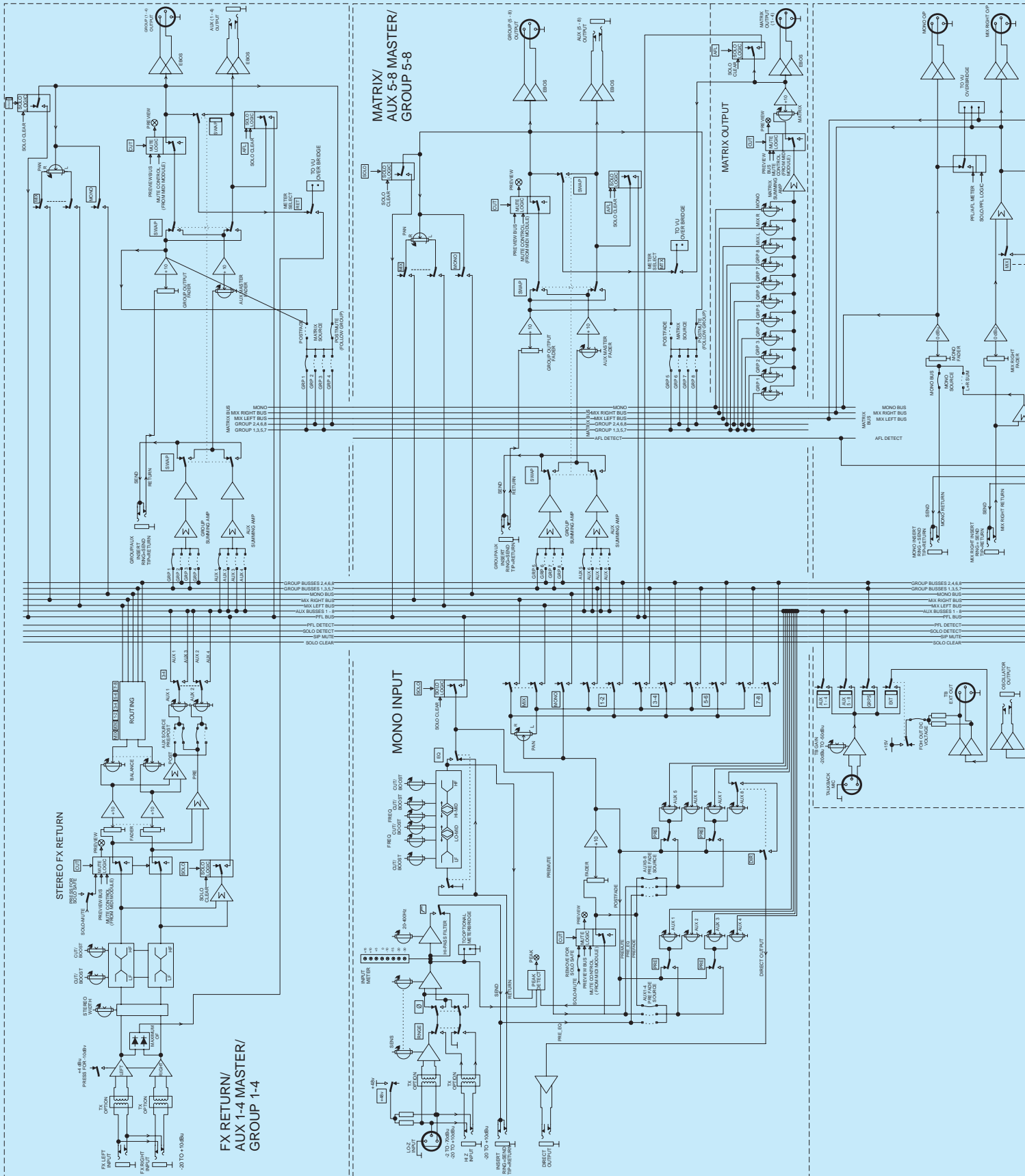

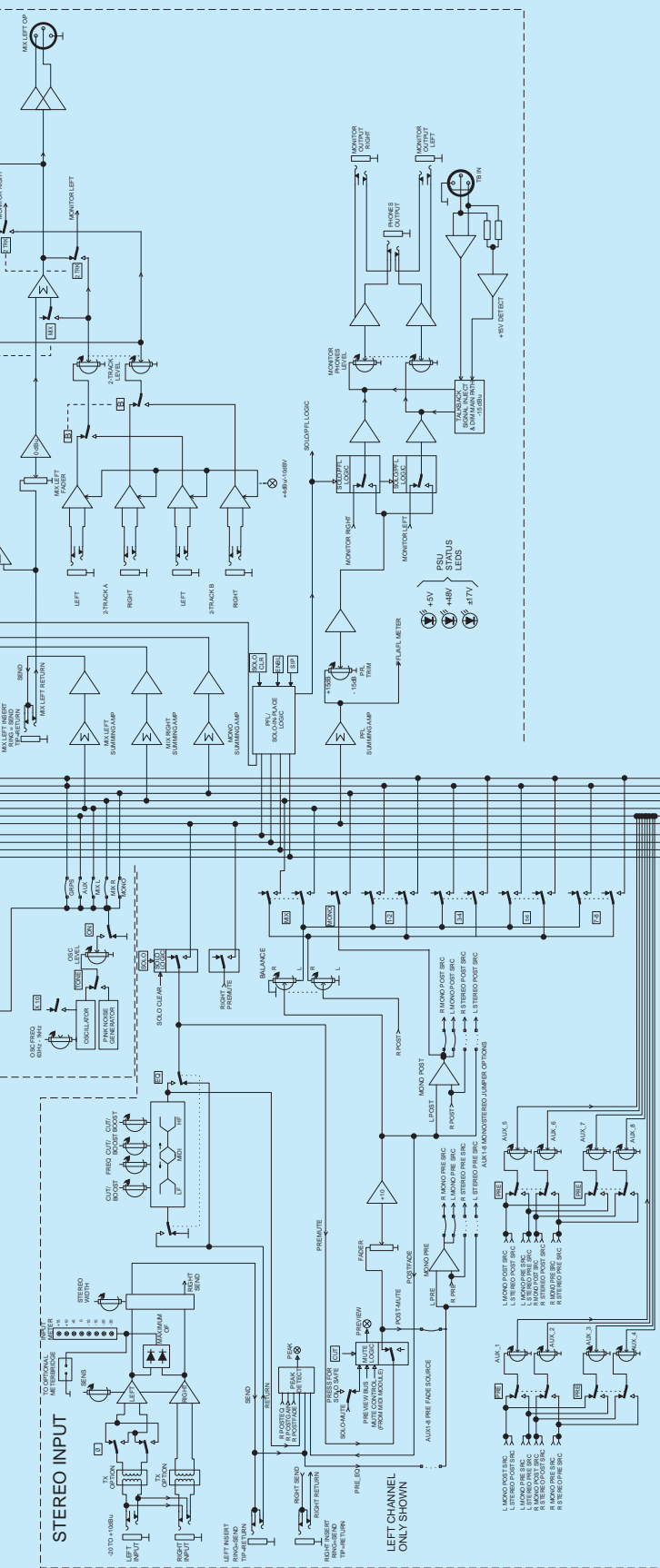

Swap switch.

Normally, the group bus signal passes through the insert point and fader to the group output, and the aux signal goes via the rotary pot to its output.

When the Swap button is pressed, the aux signal passes through the insert and fader, then back to its output. The group signal goes via the rotary pot.

The GRP to L-R and matrix feeds always stay with the group signal.

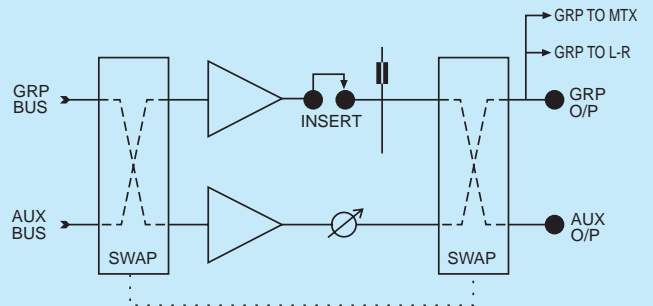

EQ Curves

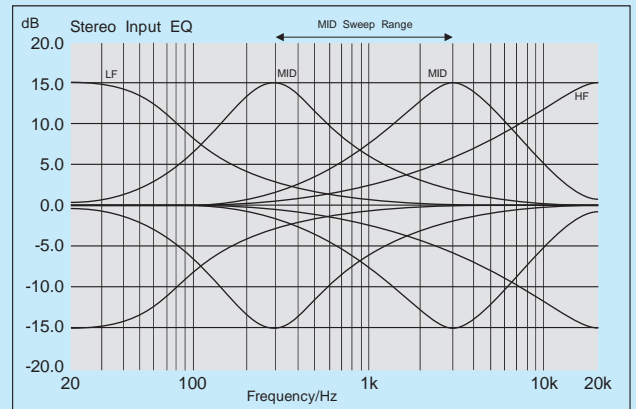
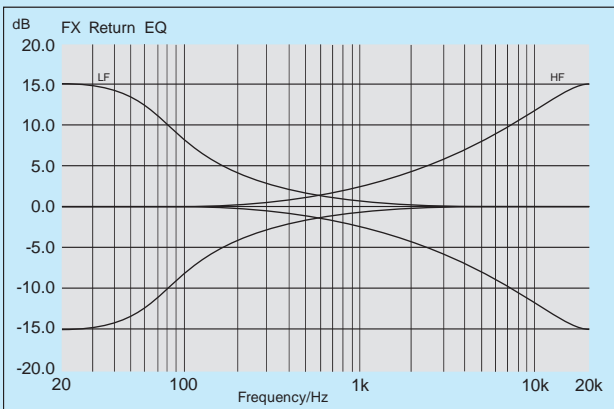
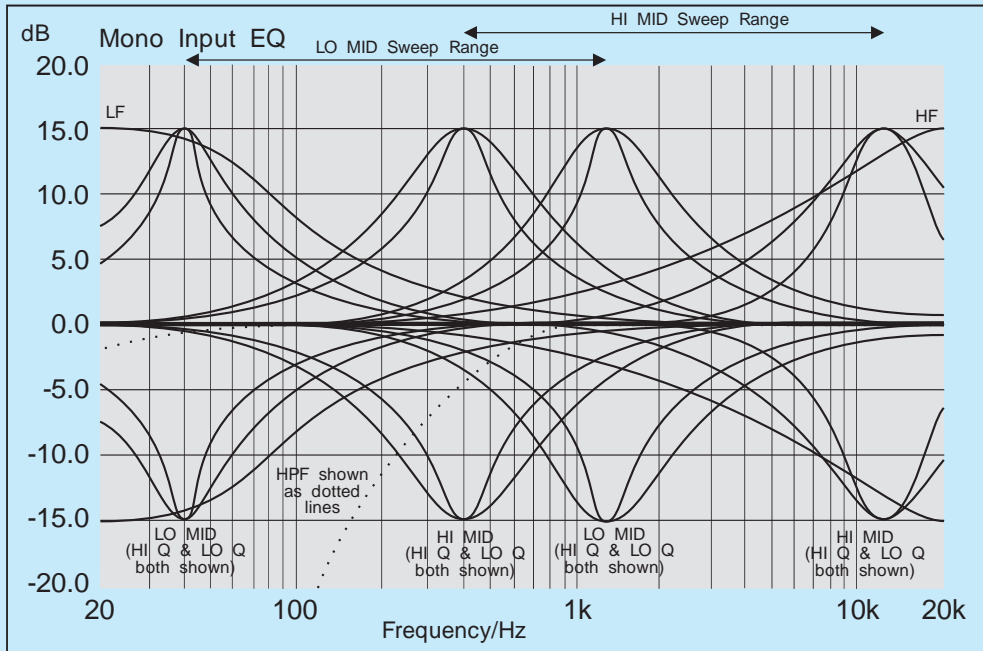

Level Diagram

K2 NOMINAL LEVEL DIAGRAM

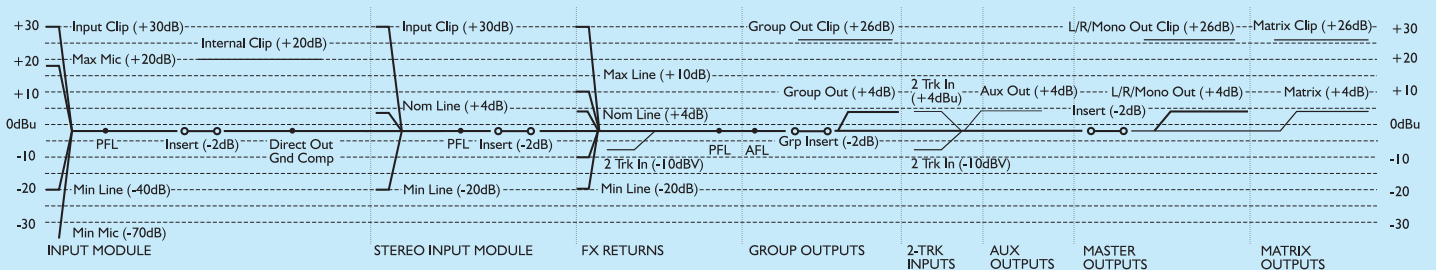

Architect's Specification

The **Mixing Console** shall be constructed in a rigid, monocoque frame, and shall be available in 24, 32, 40 and 48 input sizes. All internal PCBs shall be individual for each channel. The mixing console shall provide eight auxiliary sends, eight mono subgroups, as well as stereo and mono (centre) master outputs. A Mute Scene Set system shall be included, enabling up to 128 scenes to be stored and recalled, with eight mute groups. The console shall be provided with four Stereo Inputs, four FX Returns, Master Section and MIDI Scene Set Section. There shall be a fully flexible matrix system.

The console will be supplied with a separate CPS275 19" rack-mounting power supply or equivalent.

The **Mono Input** shall have the following features; an electronically balanced low-impedance input via an XLR socket and high-impedance input on a three-pole balanced jack with a continuously variable gain giving a sensitivity range of -20dBu to -70dBu (high gain range) and -20dBu to +10dBu for high level inputs, switchable 48V phantom power, a 20 - 400Hz High-pass filter and phase switch. A by-passable 4-band semi-parametric equaliser shall be provided with shelving response HF and LF controls with cut-off points at 12kHz and 60Hz, and two mid-frequency controls covering the range of 400-12kHz and 40Hz to 1.2kHz with a switched Q of 1.3 or 2.6. All bands shall have a cut and boost of 15dB (centre detented). Eight auxiliary sends shall be provided with individual level controls and pre/post fader switching in pairs with internal selection to pre-insert, pre-mute and pre-fade. The direct output shall be switch-selectable from post-fade or from the Aux 8 pot. Routing to the eight subgroups shall be post-pan, in pairs via switches. The pan control also feeds the stereo mix bus via the mix switch. Routing to the mono (centre) mix shall be via a separate switch. Solo and Cut switches shall control the main signal path and allow the prefade signal to be monitored at all times. An

8-segment LED meter and a separate peak indicator shall be provided, plus a Preview LED to indicate the mute status of each channel for the previewed scene or mute group. There shall be a pre-EQ insert point using a jack. The **Stereo Input** shall have the following features; stereo line level input on balanced jacks with a continuously variable gain range giving a sensitivity of -20dBu to +10dBu and a width control to vary the image from mono to a phase-enhanced stereo, a by-passable 3-band equaliser with shelving HF and LF operating at 12kHz and 60Hz and a mid control covering the range of 300-3kHz with a Q of 1, all controls having 15dB of cut and boost. Access to all eight auxiliaries shall be possible with paired switch selection of pre and post fader, all the auxiliaries shall be internally selectable to be fed with a mono sum of left and right, or to operate as stereo pairs. A 100mm fader, and illuminated Cut switch with Preview LED, a stereo balance control and routing switches to the main mix, mono (centre) mix and 8 subgroup buses shall be provided. An 8 segment LED meter, Peak LED and illuminated Solo switch will allow monitoring at all times.

Eight Group Outputs, eight Aux Outputs, four FX Returns and four Matrix Outputs shall be provided, using four combined FX Return/Aux/Group master channels and four combined Matrix/Aux/Group master channels. The Group Master sections shall each have a 100mm fader, an illuminated Cut switch and a preview LED. The Group output shall be routable to the main mono (centre) bus via a switch, and to the main stereo buses via a pan pot and a switch. It shall have an insert point via a jack. Each Aux Master section shall have a rotary fader and an illuminated AFL switch. There shall also be a Swap switch which will route the Aux Master signal through the Group path and vice versa. The metering shall follow the linear fader. Each FX Return module shall have width and balance controls, two-band shelving EQ, a 60mm linear fader, routing to all eight groups and the mix buses, illuminated

Cut and Solo switches and two Aux sends providing access to either Aux 1 and 2 or 3 and 4. There shall also be a Meter Select switch which allows the appropriate meter to monitor the FX return signal instead of the Group/Aux output. Each Matrix Module shall receive a contribution from each of the 8 groups, Mix L, R and mono (centre). The Matrix Module output shall be controlled by a master rotary fader with associated illuminated Cut and AFL controls. The Output shall be electronically balanced. There shall also be a Meter Select switch which allows the appropriate meter to monitor the Matrix Output signal instead of the Group/Aux output.

The **Master Module** shall have 2 x 100mm master faders which may be selected to control L and R or L/R and mono (centre) outputs, Solo Clear, Solo-in-Place and Auto Cancel selection, Talkback microphone socket and switching, oscillator and monitor controls.

The console will have an overbridge as standard, with 3 large VU meters to monitor Left Mix, Right Mix and mono (centre) Mix/AFL/PFL; it will also have 8 smaller VU meters to monitor Group/Aux Outputs, FX returns and Matrix Outputs.

The MIDI Scene Set section shall be capable of storing up to 128 scenes comprising mono and stereo input, group and matrix mutes, and MIDI Program changes. A three-digit LED display shall be used to show scene number, MIDI channel or program change for the current or preview scene. Eight preset buttons shall be used to assign mute groups. A Preview facility shall be provided which will display the mute status of the console for any scene or mute group without affecting the audio mutes. Presetting of external devices shall be possible via MIDI Program Changes and Note On/Off data.

The dimensions and specifications shall be as published on the rear cover of this brochure. The console shall be the Soundcraft K2.

Rear Panel Connections

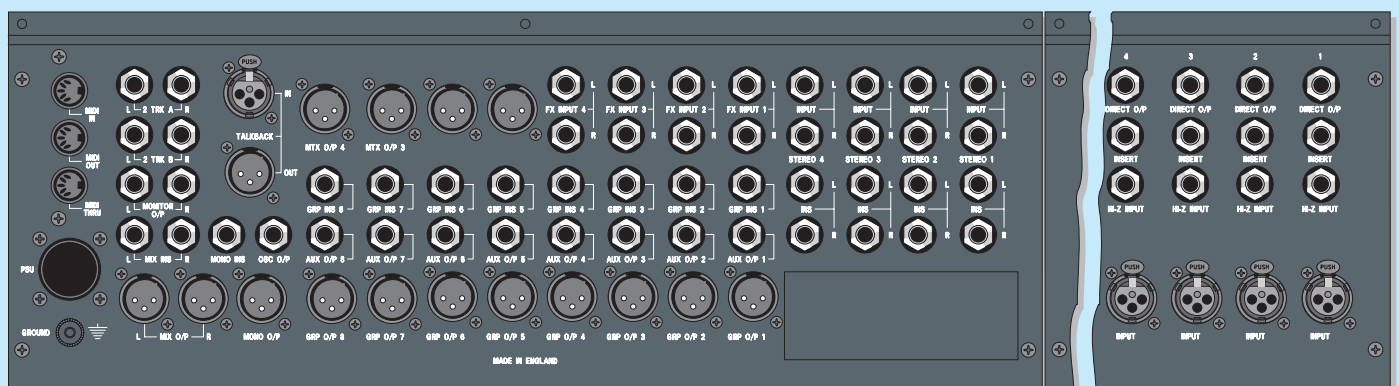

K2 Typical Specifications

Connections	Impedance	Level		
Low Impedance Input (XLR)	1.6kΩ bal. -70dBu to -2dBu (+18dBu max)/-20dBu to +10dBu (+30 max)			
High Impedance Input (Jack)	>10kΩ balanced	-20dBu to +10dBu (+30dBu max)		
Insert (Jack)	Unbalanced Send/Return 75Ω/10kΩ	-2dBu (+21dBu max)		
Direct Out (Jack)	75Ω ground compensated	-2dBu (+21dBu max into 2kΩ)		
FX Return (Jack)	(+4dBu)>10kΩ balanced	+26dBu max		
2 - Trk Input (Jack)	(-10dBV)>10kΩ balanced	+12dBV max		
	(+4dBu)>10kΩ balanced	+26dBu max		
	(-10dBV)>10kΩ balanced	+12dBV max		
Group Insert (Jack)	Unbalanced Send/Return 75Ω/10kΩ	-2dBu (+21dBu max)		
Group Output (XLR)	75Ω balanced	+4dBu (+26dBu max into 1kΩ)		
Aux Output (Jack)	75Ω balanced	+4dBu (+26dBu max into 1kΩ)		
Matrix Output (XLR)	75Ω balanced	+4dBu (+26dBu max into 1kΩ)		
L/R/Mono Insert (Jack)	Unbalanced Send/Return 75Ω/10kΩ	-2dBu (+21dBu max)		
L/R/Mono Output (XLR)	75Ω balanced	+4dBu (+26dBu max into 1kΩ)		
EQ and Filter				
HP Filter	Freq.	20-400Hz		
	Slope	12dB/Oct		
HF	Freq.	12kHz		
	Gain	±15dB		
HMF	Freq.	400Hz to 12kHz		
	Gain	±15dB		
	Q.	1.3/2.7		
LMF	Freq.	40Hz to 1.2kHz		
	Gain	±15dB		
	Q.	1.3/2.7		
LF	Freq.	60Hz		
	Gain	±15dB		
Auxiliaries				
1/2, 3/4, 5/6, 7/8		Pre/Post-fade switched		
Oscillator				
		63Hz to 10kHz/Pink Noise variable level		
Frequency response				
Any input to any output (measured at up to +50dB gain)		+0/-0.5dB, 20Hz -20kHz		
THD and Noise				
High impedance I/P to Group or Mix O/P (measured at +20dBu output)		Less than 0.005%THD@ 1kHz		
Mic input EIN (22Hz - 22kHz bandwidth, unweighted)		Less than -127dBu (150Ω source)		
Mix bus output noise (40ch routed)		Less than -80dBu		
Crosstalk (All measurements at 1kHz)				
Channel muting		Greater than 90dB		
Channel routing and Channel fader attenuation and Aux Send attenuation		Greater than 80dB		
Dimensions (Width/Weight)				
CH	mm	inches	kgs	lbs
24	1247	49.09	40	88
32	1503	59.17	50	110
40	1735	68.30	60	132
48	1967	77.44	70	154

Note: These figures are typical of performance in a normal electromagnetic environment. Performance may be degraded in severe conditions



SOUND-CRAFT
 HARMAN INTERNATIONAL INDUSTRIES LTD.
 CRANBORNE HOUSE, CRANBORNE ROAD,
 POTTERS BAR, HERTS, EN6 3JN, UK.
 TEL: +44 (0)1707 665000
 FAX: +44 (0)1707 660742
 EMAIL: info@soundcraft.com
 http://www.soundcraft.com

SOUND-CRAFT US
 1449 DONELSON PIKE
 NASHVILLE TN 37217, USA.
 TEL: 1-615-360-0471
 FAX: 1-615-360-0273
 EMAIL: soundcraft-usa@harman.com

Part No. A4; ZL0381
 US; ZL0382

Soundcraft reserve the right to improve or otherwise alter any information supplied in this document or any other documentation supplied hereafter. E&OE 08/01

This equipment complies with the EMC Directive 89/336/EEC



H A Harman International Company